

1/3	ACCU - SPINDELMÄHER
2008	ACCU-HAND-LAWNMOWER
Rev083404	Tondeuse à lame hélicoïdale Accu

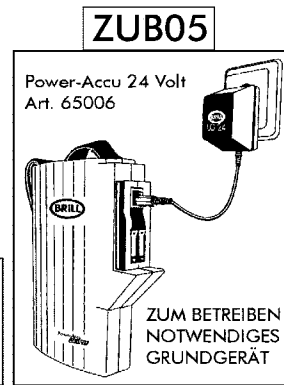

RAZORCUT Accu 38 - Art. 65070
2008

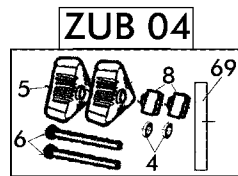
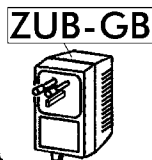
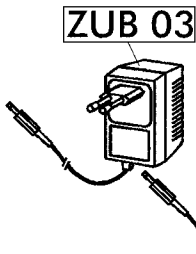
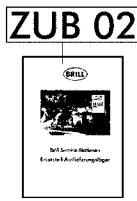
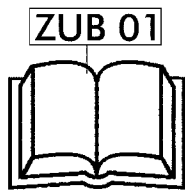
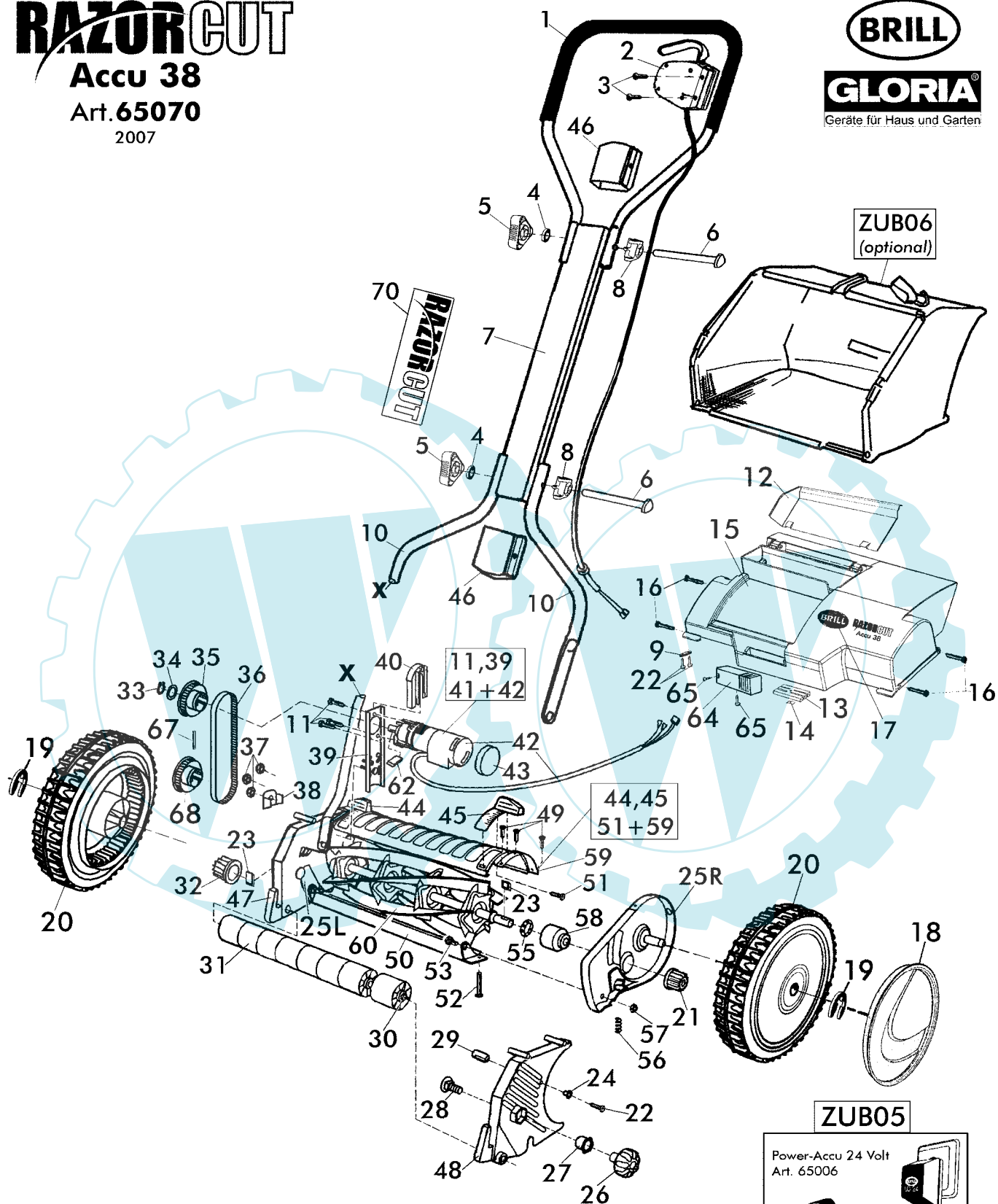

RAZORCUT
Accu 38
Art. 65070
2007



Technische Änderungen vorbehalten

Bild Nr. REF.N° POS.N°	BEST.-NR. PART-N° N° d. PIECE	BEZEICHNUNG	DESCRIPTION	Anzahl Qty. Qte.
2/3	ACCU - SPINDELMÄHER			
2008	ACCU-HAND-LAWNMOWER		 Accu 38 - Art. 65070  	
Rev083404	Tondeuse à lame hélicoïdale Accu		2008	
1	15223	HOLM-OBERTEIL 65070 KPL.	UPPER HANDLE BAR INCL.SOFT GRIP	1
2	15220	TOTMANNSSCHALTER DC I=8A	DEATH-MAN-SWITCH 8A	1
3	11623	PT-SCHRAUBE K40X25	PT-SCREW	2
4	06464	SCHEIBE DIN 125-A6,4	WASHER DIN 125-A6,4	2
5	15235	HOLMSPANNGRIFF	TENSIN GRIPP	2
6	15205	SCHRAUBE DIN 931-M6x140	SCREW DIN 931-M6x140	2
7	15287	HOLM-MITTELTEIL 65070-2007	MIDDLE HANDLE BAR ASSY. 65070-2007	1
8	15274	SPANNTEIL M.KABELHALTER	TENSION PART INCL. CABLE CLIP	2
9	11832	KABELKLEMME 2	CLAMP 2	1
10	15240	GESTÄNGE-UNTERTEIL 65070-2007	LOWER HANDLE BAR 65070-2007	2
11	11701	LIB-SCHRAUBE DIN 7981-3,5x25	LIB-SCREW	3
12	15191	KLAPPE RAL 7021	CLAP	1
13	12871	ISO-KÖRPER 3-POLIG	CABLE BODY 3-P	1
14	12869	FEDERMUTTER Form 10	FASTENER	1
15	15193	HAUBE RAL6001 BEDRUCKT	COVER RAL6001 65070	1
16	08541	SCHRAUBE D 7981-4,2X32	SCREW	4
17	15234	BRILL-GLASKÖRPERLOGO	BRILL-LOGO	1
18	15547	RADKAPPE	WHEEL COVER	2
19	06496	SICHERUNGSRING D 471-15x1	SEEGERRING	2
20	15187	LAUFRAD KPL	WHEEL	2
21	00464	SPERRZAHNRAD,RECHTS	RATCHET WHEEL /R	1
22	11020	SKT-SCHRAUBE DIN 7976-B3,9x13	SCREW	4
23	00451	SPERRHAKEN 70060	BLOCK-CLAMP	2
24	03296	SCHEIBE	WASHER	2
25L	15246	SEITENBACKE LKS. 65070 KPL. 2007	FRAME L.H. 65070-2007 ASSY.	1
25R	15247	SEITENBACKE RTS. KPL.GEP. 2007	FRAME R.H. 2007 ASSY.	1
26	00310	HANDRAD 70060	ARRESTOR GRIP	2
27	00358	SPANNTOPF	LOCK SPACER	2
28	00326	FLR-SCHRAUBE D 603-10x25	SCREW	2
29	00665	GESTAENGE BOLZEN 70060	BOLT	2
30	08206	LAUFROLLENACHSE 38	REAR ROLLER AXLE 38	1
31	00441	LAUFROLLE 70060	REAR ROLLER	7
32	11399	SPERRZAHNRAD LKS	RATCHET WHEEL 2/LEFT	1
33	09131	SICHERUNGSRING	SEEGERRING	1
34	11379	SCHEIBE	WASHER	1
35	11378	ZAHNRIEMENRAD	GEAR WHEEL	1
36	11389	ZAHNRIEMEN HDT-390-3M-9	TOOTH BELT	1
37	06682	SI-MUTTER DIN 985-5	NUT	3
38	11385	SPANNKEIL	TENSION KEY	1
40	11522	STAUBSCHUTZKAPPE	DUST COVER	1
11,39, 41+42	12756	ANTRIEBSEINHEIT KOMPL.380ASM	DRIVE UNIT ASSY. 380 ASM	1
43	11391	SCHAUMFILTER	FOAM	1
44	11679	SCHIEBEGRIFF LKS. BEDR.	HIGH ADJUSTMENT GRIP L.H.	1
45	11680	SCHIEBEGRIFF RTS BEDR	HIGH ADJUSTMENT GRIP R.H.	1
46	15201	KAPPE	CAP	2
47	11684	LAUFROLLENLAGER LKS	REAR ROLLER BEARING LEFT	1
48	11685	LAUFROLLENLAGER RTS	REAR ROLLER BEARING RIGHT	1
49	00608	SPIRALFORMSCHRAUBE	SCREW	6
50	11096	UNTERMESSER 38 CM	LOWER BLADE 38	1
51	06820	SCHRAUBE DIN 7981-4,2X13	SCREW	2
52	00116	SCHRAUBE M.KUGELKOPF	SCREW	2
53	03424	BOLZEN	BOLT	2
55	00493	KUGELLAGER KL 5,14	BALL BEARING KL 5	2

3/3	ACCU - SPINDELMÄHER		RAZORCUT Accu 38 - Art. 65070	 
2008	ACCU-HAND-LAWNMOWER			
Rev083404	Tondeuse à lame hélicoïdale Accu			
Bild Nr. REF.N° POS.N°	BEST.-NR. PART-NO. NO d. PIECE	BEZEICHNUNG	DESCRIPTION	Anzahl Qty. Qte.
56	00682	FEDER 70060	SPRING	2
57	06684	S-MUTTER DIN 985-8	NUT	2
58	00521	WICKELSCHUTZ	COIL GUARD	2
44,45, 51+59	15221	VERBINDUNGSGEHÄUSE KPL.	CONNECTION HOUSING 65070 CPL.	1
59	15189	VERBINDUNGSGEHÄUSE 65070	CONNECTION HOUSING 65070	1
60	11373	MESSERWALZE 38 cm	BLADE CYLINDER	1
62	11624	SPERRHAKEN GEHÄRTET	HARDENER BLOCK-CLAMP	1
64	13745	KUPPLUNG 380 ASM CSAKPL.	ELECTRIC CLUTCH CSA ASSY.	1
65	11913	BLECHSCHRAUBE DIN 7981 4,2x9,5	SCREW	3
67	11384	SPIRALSPANNSTIFT 4040	PIN	1
68	13300	ZAHNRIEMENRAD 2	GEAR WHEEL 2	1
70	15301	AUFKLEBER RazorCut	LABEL RazorCut	1
		Z U B E H Ö R	ACCESSORIES	
ZUB01	15227	GEBRAUCHSANWEISUNG 65070-2007	INSTRUCTION FOR USE 65070-2007	1
ZUB02	00563	BRILL-Service-Verzeichnis	BRILL-Service-Booklet	1
ZUB03	11917	LADEGERÄT 65035 (D)	CHARGER 65035 (D)	1
ZUB-GB	12908	LADEGERÄT 65035 (UK)	CHARGER 65035 (UK)	1
ZUB 04	15275	ZUBEHÖR 65070-2007	ACCESSORIES ASSY. 65070-2007	1
4	06464	SCHEIBE DIN 125-A6,4	WASHER DIN 125-A6,4	2
5	15235	HOLMSPANNGRIFF	TENSIN GRIPP	2
6	15205	SCHRAUBE DIN 931-M6x140	SCREW DIN 931-M6x140	2
8	15274	SPANNTEIL M.KABELHALTER	TENSION PART INCL. CABLE CLIP	2
69	08183	EINSTELLEHRE Z.SCHNITT 0,05	ADJUSTING GAUGE 0,05	1
ZUB05	65006	POWER ACCU 24 PA KPL.INKL.LADEGERÄT	POWER ACCU PA24V INCL.CHARGER	1
ZUB06	65041	RazorCut-Fangsack 38 (Optional)	RazorCut-Grass catcher 38 (optional)	1